

## OPERATING INSTRUCTION

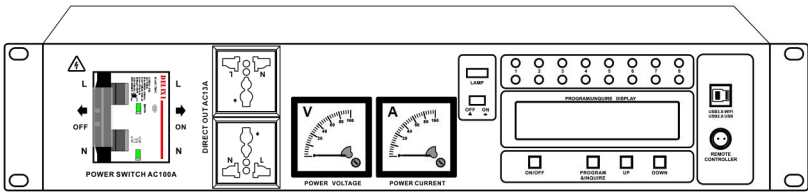

## POWER SEQUENCER



SANWAY AUDIO

<https://www.china-sanway.com>

---

## Attention

**Warning:** To prevent the short circuit, keep the device away from any place of humidity.

Turn off the device immediately in case of water damage and find the right technician for reparation.

Do not open the device yourself unless by the authorized technician.

When you see the exclamation Mark flashing, the device is also with high voltage and the alert should be on.

When you see the arrowhead signal flashing, the device is with high voltage.

Please do not touch the device for any reason.





SANWAY AUDIO

<https://www.china-sanway.com>

## Packing list

Make sure all the items are in the package



Device

Quantity: 1



Operating Instruction

Quantity: 1



CD

Quantity: 1



USB2.0 cable

Quantity: 1



Warranty card and certificate

Quantity: 2



Fuse  
(Size: F500mA L250V)  
Quantity: 1





## Table of content

---

### Part I : Device connection methods

1.1 Connect the device with single device via USB	(01)
1.2 Connect PC with single device via RS485	(01)
1.3 Connect the PC with multiple devices via RS485	(02)
1.4 Connect device with central system	(03)
1.5 Connect multiple devices together	(05)
1.6 Connect TCP/IP with computer	(06)
1.7 Connect network with WIFI	(11)
1.8 Methods of checking the port	(18)
1.9 Methods of checking and modifying the related parameters	(20)

### Part II : The method of operating the device

2.1 Functions	(28)
2.2 Introduction of front panel	(28)
2.3 Introduction of back panel	(29)
2.4 SPECIFICATION	(30)
2.5 Menu setting method	(31)
2.6 The method of connecting remote control	(32)

### Part III : The installation and operation of PC software

3.1 The USB driver installation	(33)
3.2 The installation of software	(33)
3.3 The connection of software	(34)
3.4 The solutions of disconnection problem	(34)
3.5 The introduction for the software interface and how to operate	(35)
— 3.5.1 The connection between the software and PC & Use the software to modify the ID	(35)
— 3.5.2 The introduction of the software function	(36)
— 3.5.3 The introduction of “Editing timing” function	(38)
— 3.5.4 The lock function for PC software and device	(43)
— 3.5.5 Load and save the data	(45)



## Part 1: Device connection method.

### 1.1 Connect the device with single device via USB

Use the equipped USB cable to connect the PC's USB port to the device panel's USB port and turn on the power. This method is applicable for connecting the PC and device in a short distance (Cable length of USB2.0 or USB3.0 should be within 30 meters). As shown in figure 1 below:

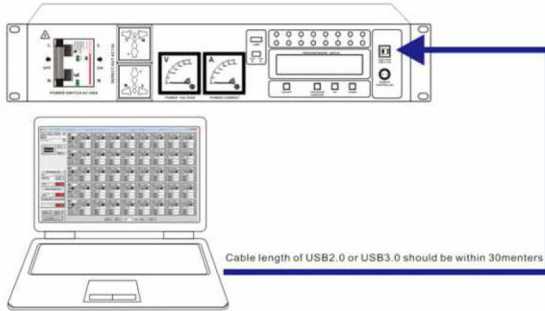

picture 1

### 1.2 Connect PC with single device via RS485

Step 1: Set the device ID to be "1". Long press on buttons "PROGRAM & INQUIRE" until LCD twinkles. Click on "UP" and "DOWN" buttons to set ID to be "1".

Step 2: Use the optional USB to RS485 protocol communication or other RS485 to connect the PC USB port to the LINK IN port on the rear panel. This connecting method is applicable for controlling the device remotely by PC. The control distance can be up to 600 meters (as shown in below picture 1). LINK IN Port and LINK OUT Port on the rear panel is shown in below picture 2.

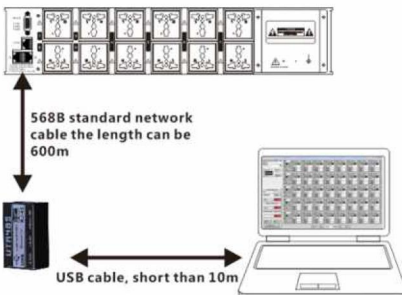

picture 1

- 1: CENTRAL CONTROL RS485 A
- 2: CENTRAL CONTROL RS485 B
- 3: GND
- 4: LINK A/PC RS485 A
- 5: LINK B/PC RS485 B
- 6: GND
- 7: GND
- 8: GND



picture 2

Step 3: open software in PC, choose RS485 connecting way to connect PC with device.



### 1.3 Connect the PC with multiple devices via RS485

**Attention:**

When multiple devices are connected with each other, the ID of the device must be set continuously from 1, and the ID number cannot be duplicated, up to 250 devices.

Step 1: Set device's ID from 1, 2, 3... Power on the device and long press on buttons "PROGRAM & INQUIRE", until LCD twinkles. Click on "UP" and "DOWN" buttons to set ID to be "1" for the first device. Same method can be used when set ID for other devices.

Step 2: Use the optional USB to RS485 protocol communication or other RS485 to connect the PC USB port to the LINK IN port on the rear panel. This connecting method is applicable for controlling the device remotely by PC. The control distance can be up to 600 meters (as shown in below picture 1). LINK IN Port and LINK OUT Port on the rear panel is shown in below picture 2.

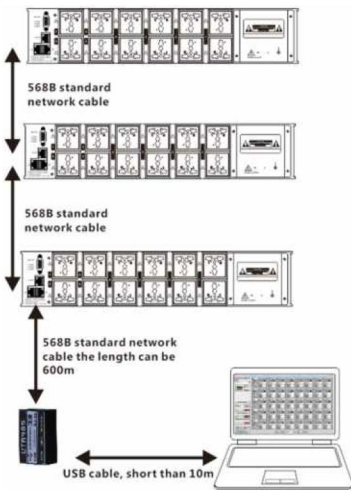

picture 1

- 1: CENTRAL CONTROL RS485 A**
- 2: CENTRAL CONTROL RS485 B**
- 3: GND**
- 4: LINK A/PC RS485 A**
- 5: LINK B/PC RS485 B**
- 6: GND**
- 7: GND**
- 8: GND**



picture 2

Step 3: open software in PC, choose RS485 connecting way to connect PC with device.



### 1.4 Method of connecting device with central system

Connect single device with central control system: connect the RS485 port of the central control system to the network cable port of the device rear panel as the picture 1.

(Central control system 485 A connect to CENTRAL CONTROL RS485 A, central control system 485 B connect to CENTRAL CONTROL RS485 B)

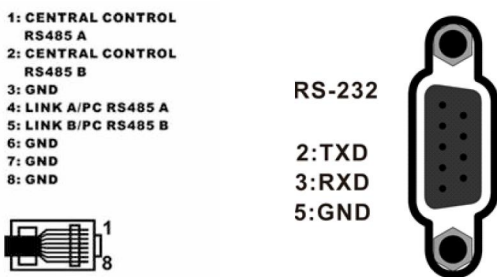

picture 1

When multiple devices are connected with central control, the ID of the device must be set continuously from 1, and the ID number cannot be duplicated, up to 250 devices. As shown in below picture 2..

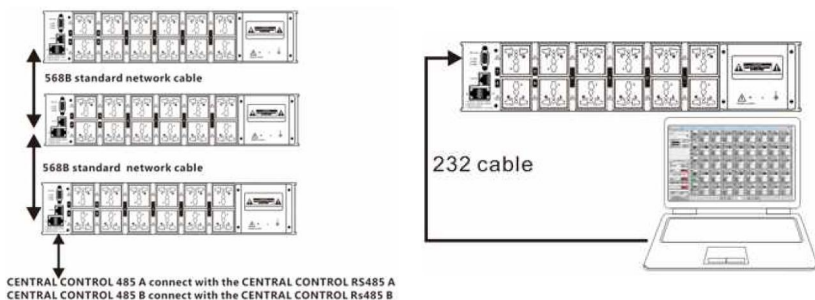

picture 2

Central control code (applicable for central control RS485 control)  
Baud rate: 9600



**Read the Channel:** 0xD0 0xD0 0xD0 0x01 **ID** 0x01 0x01 0x00 0xEE  
Return: 0xD0 0xD0 0xD0 0x03 0xFF 0x0C **0xMM 0xMM 0xMM 0xMM 0xMM 0xMM**  
**0xMM 0xMM 0xMM 0xMM 0xMM 0xMM 0xMM 0xEE**

Explanation:  
1. ID is 1-250 (Correspond to the ID need to be read)  
2. 12 0xMM are corresponding to 12 channels state, when 0xMM is 0x01, channel is opened. When 0xMM is 0x00, the channel is closed.

For example: Read the channel state of ID 1  
Send: D0 D0 D0 01 **01** 01 01 00 EE  
Return: D0 D0 D0 03 FF 0C **01 01 01 01 00 00 00 00 00 00 00 00** 0xEE  
From the return data, we can find that the channel 1-4 is opened and channel 5-12 are closed.

Write channel state: 0xD0 0xD0 0xD0 0x02 **ID** 0x02 0x0C 0xMM 0xMM 0xMM 0xMM  
0xMM 0xMM 0xMM 0xMM 0xMM 0xMM 0xMM 0xMM 0xEE  
Return: 0xD0 0xD0 0xD0 0x00 0xFF 0x01 0x00 0xEE

Explanation:  
1. ID is 1-250 (Correspond to the ID need to be read)  
2. 12 0xMM are corresponding to 12 channels state, when 0xMM is 0x01, channel is opened. When 0xMM is 0x00, the channel is closed.

For example: Make the device (ID number is 1) to open the channel 1-6 and close the channel 7-12  
Send: D0 D0 D0 02 **01 02 0C 01 01 01 01 01 00 00 00 00 00 00** EE  
Return: D0 D0 D0 00 FF 01 00 EE

**Write linking state:** 0xD0 0xD0 0xD0 0x02 **ID** 0x03 0x01 **0xMM** 0xEE  
Return: 0xD0 0xD0 0xD0 0x00 0xFF 0x01 0x00 0xEE

Explanation:  
1. ID is 1-250 (Correspond to the ID need to be read)  
2. When 0xMM is 0x01, the device linking is opened, and when 0xMM is 0x00, the device linking is closed.

For example: Link the device (ID number is 1)  
Send: D0 D0 D0 02 **01 03 01 01** EE  
Return: D0 D0 D0 00 FF 01 00 EE





### 1.5 Connect multiple devices together

Attention:

When multiple devices are connected with each other, the ID of the device must be set continuously from 1, and the ID number cannot be duplicated, up to 250 devices.

Step 1: Set the device ID to be "1". Long press on buttons "PROGRAM & INQUIRE" until LCD twinkles. Click on "UP" and "DOWN" buttons to set ID to be "1", using the same way to set the other devices.

Step 2: Using cable 568B to connect multiple devices together. The control distance can be up to 600 meters (as shown in below picture 1).

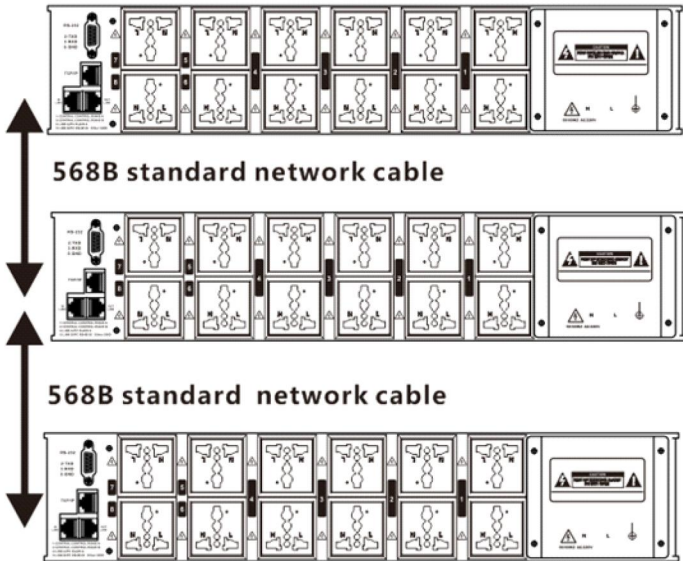

picture 1



### 1.6 Introduction for 3 ways of connecting TCP IP with

#### Computer

Cable (5 types)

Method 1: : Device -----> Computer

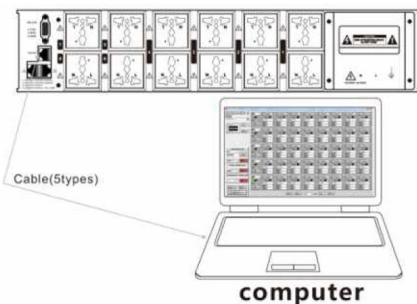

Step 1: Make IP address of device to be as the same as PC. (For example if the device IP Address is 

IP	SET
010.010.100.254	

, PC IP address must be 

10.10.100.254	Not Connected
---------------	---------------

)

Step 2: Click this icon if PC is wireless connection and choose [open network and sharing center](#) and click change adapter settings, click wireless forbidden connection, and then click local connection start; or if computer has local connection (this con) and please click [open network and sharing center](#) to change adapter settings.

Step 3: Click local connection options  Internet Protocol Version 4 (TCP/IPv4) and double click to change the IP address and click to confirm. As shown in below figure 1.

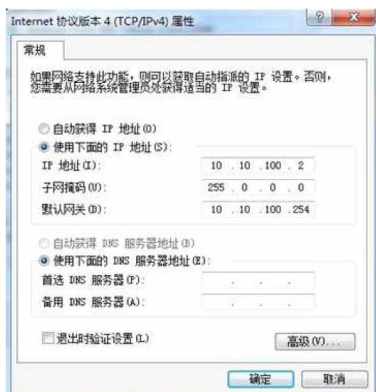

picture 1

If all above procedures have been followed and software and device will connect to each other.



Cable (5 types) Cable (5 types)

Method 2: Device -----> Router -----> Computer

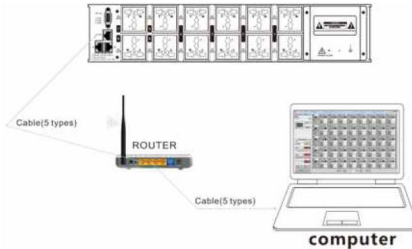

Step 1: Make IP address of device to be as the same as PC. (For example if the device IP Address is 010.010.100.254, PC IP address must be 10.10.100.254)

Step 2: Click this icon [signal icon] if PC is wireless connection and choose open network and sharing center and click change adapter settings, click wireless forbidden connection, and then click local connection start; or if computer has local connection (this [network icon] icon) and please click open network and sharing center to change adapter settings. Click local connection options [checked] Internet Protocol Version 4 (TCP/IPv4) and double click to change the IP address and click to confirm. As shown in below figure 2.

Step 3: set the IP address of router. The original login address of router can be found in address bar. (For example if the IP address is 192.168.1.1 and then enter 192.168.1.1) and enter user name and password like below figure 3. Click confirm and a dialog box will pop up like below figure 4 and choose static IP like figure 5 and click next and enter 10.10.100.3 like figure 6. (Please be noted that the last number of static IP address cannot be as the same as the IP address of local connection, like below figure 7) click next and choose do not change wireless security settings like figure 8 and then click next like figure 9.

Step 4: Click local area connection properties [checked] Internet Protocol Version 4 (TCP/IPv4) and click then double click to change the IP address and click confirm like below figure 1.



picture 2



picture 3

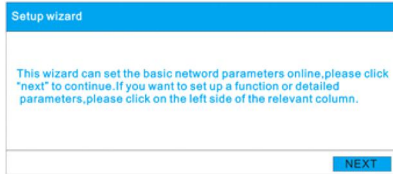

picture 4

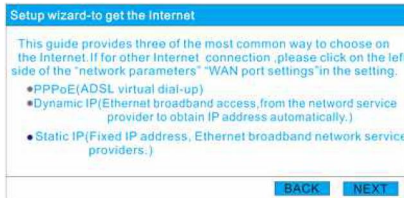

picture 5

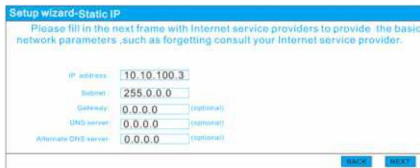

picture 6

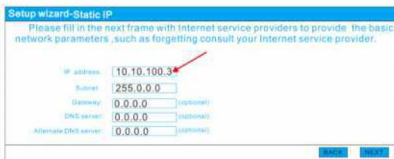

picture 7



picture 8

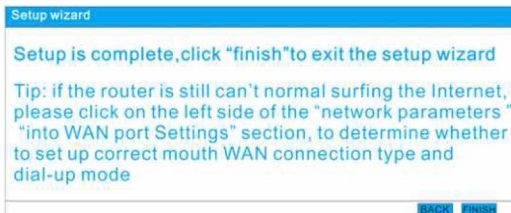

picture 9



If all above procedures have been followed and software and device will connect to each other.

Cable (5 types ) wireless network

Method 3 : : Device -----> Router -----> Computer

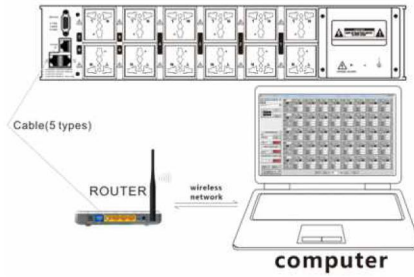

Step 1: Make IP address of device to be as the same as PC. (For example if the device IP Address is 192.168.1.100, PC IP address must be 10.10.100.254)

Step 2: Click this wireless connection icon and choose router wireless IP address like below figure 10 and click to connect. Click "connect to internet without setting up network interface" like below figure 11. And click this wireless connection icon and left click the mouse. And choose state Status and click property and choose Internet Protocol Version 4 (TCP/IPv4) and then double click to obtain IP address like below figure 2.

Step 3: the way of setting router is as same as above step 3 of method 2. Please refer to above.

Step 4: click wireless connection icon, left click the mouse and choose the state Status and click property and choose Internet Protocol Version 4 (TCP/IPv4) double click IP address and click confirm like below figure 1.



picture 10



picture 11



If all above procedures have been followed and software and device will connect to each other.

Attention: if method 2 and method 3 connecting methods have been used, and please update the last number of IP address if you want to use 2<sup>nd</sup> way of connection. The last number can be changed from 4-253 like below figure 12.

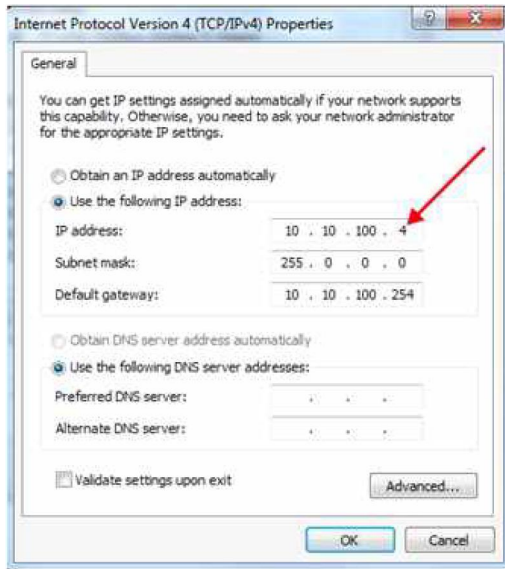

picture 12



### 1.7 Introduction of 7 methods of connecting the network (with WIFI)

Attention: The device has to be connected with WIFI module (UTW1) first. As shown in below figure 1.

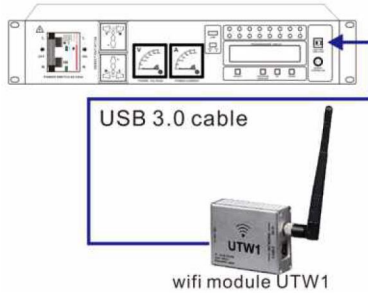

picture 1

USB3.0cable      network cable

Method 1: Device <-----> wifi module <-----> computer

According to the above figure to connect the device, the method of computer obtain IP address needed to be set to automatically (if your computer get the IP address automatically, no need to modify)

USB3.0 cable      wireless network

Method 2: Device <-----> wifi module <-----> computer

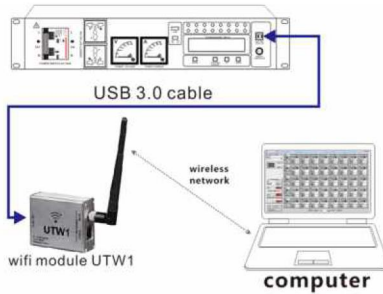

picture 2

If using this way of connection, please change the wireless mode to AP mode. Please refer to <1.9.1.4 the swap method of Station mode and AP mode> for reference.

The example under Windows XP system:

Open wireless connection and search wireless network, find the device corresponds to the wireless network name, as in pic 1

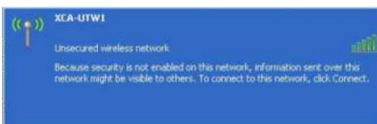

picture 1



Choose "connected", if the connection is normal, as shown in below picture.

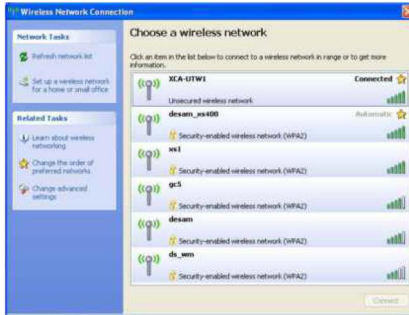

Connect to the WIFI module, under default module setting, the wireless network card IP access to TCP/IP protocol options to obtain automatically, if not, please select obtain an IP address automatically.

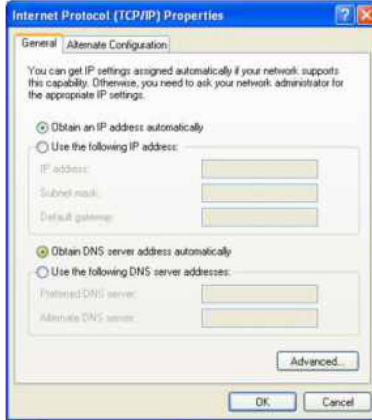

picture 1

The example under Windows 7 system:

Open wireless connection and search wireless network, find the device corresponds to the wireless network name, as in pic 1

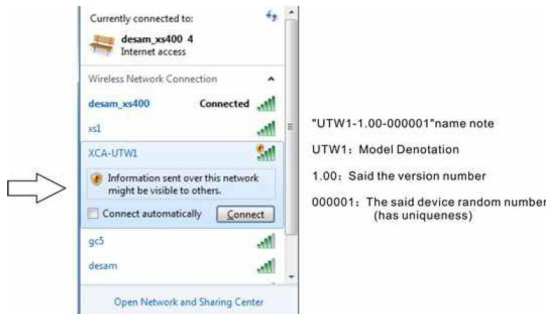

picture 1





Connect with corresponding network, if the connection is normal, as shown in below pic.



picture 1

USB3.0 cable      network cable    network cable

Method 3: Device <-----> wifi module <-----> router <-----> computer

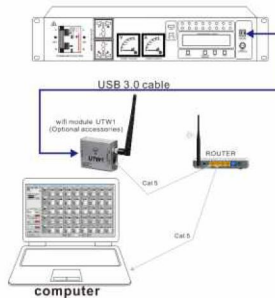

picture 1

Use this way of connecting, you might think the device as a computer within the local area network (LAN), the computer and device are through the LAN network to communicate.

Step 1: Firstly, make the device join in the local area network (LAN) and assign a static IP, setting method please take "1.6.1.1 the modification method of IP address under the AP model" for reference.

Step 2: connect the device, make the computer and device within the same network segment (if LAN gateway for 192.168.1.1, the device and computers gateway must be 192.168.1.1)

USB3.0 cable      network cable    wireless network

Method 4: device <-----> wifi module <-----> router <-----> computer

The connection mode and the third way is similar, only change the connection of router to computer to wireless connection, any other Settings are identical.

USB3.0 cable      wireless network    network cable

Method 5: device <-----> wifi module <-----> router <-----> computer

The connection mode and the third way is similar, only change the connection of router to wifi module to wireless connection, any other Settings are identical.

USB3.0 cable      wireless network    wireless network

Method 6: device <-----> wifi module <-----> router <-----> computer



The connection mode and the third way is similar, only change the connection of router to wifi module and computer to wireless connection, any other Settings are identical.

Method 7: Method 3,4,5,6 is applicable for the devices which are communicate within the same network segment . When the device in other network segment or in a distant place then we can use 7<sup>th</sup> way to communicate.

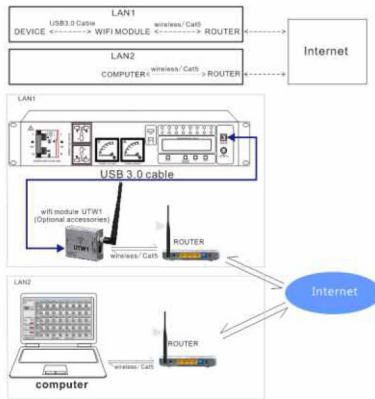

picture 1

After connecting the device, we need to make some settings as follows:

a. The wifi module enter into the LAN

Take a network cable to connect the computer and wifi module, open the browser after connecting, and input 10.10.100.254 (this is the initial system url address, if you revise it, please use the modified address) on the address bar to enter into the wifi module setting interface, input the default user name [admin] and default password[admin] and log in.

Enter into the wifi module interface to make the following settings:

1. Click on the left column [mode selection]
2. Choose [station mode] (the purpose is make the device as a customer service client, access to LAN 1)
3. Choose [transparent transmission mode] (or you also can choose other modes)
4. Press[OK] to save the parameters.

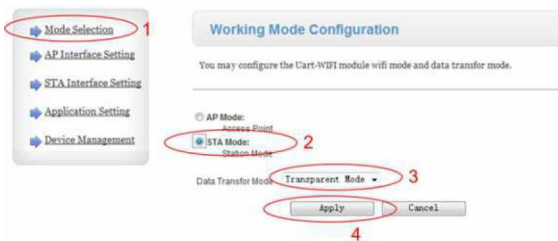

picture 1



b. Wireless access point Settings

1. Click on the left column [Wireless access point Settings]
2. Fill in the network name (named for the device)
3. Press [OK] to save the parameters.

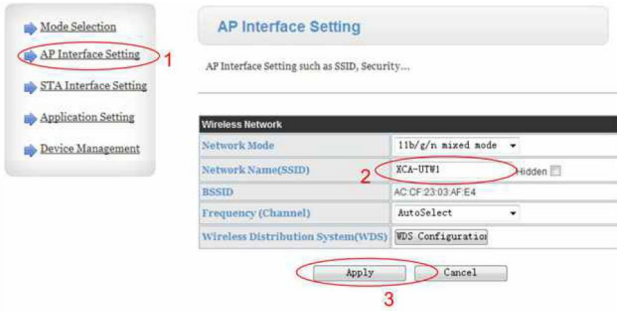

picture 1

C. Wireless terminal settings

1. Click on the left column [Wireless terminal settings]
2. Click on [search] to search the wifi hotspots in the LAN, choose the wifihotspots and fill in the password to enter into LAN1.
3. Encryption mode, choose the default option or the mode you needed.
4. Fill in the WIFI hotspots password
5. Press [OK] to save the parameters.

Module IP address settings (choose the [static fixed IP])

1. Setting the IP address (this IP address is needful when access to the internet)
2. Setting the subnet mask (in accordance with mask within the LAN1)
3. Set the LAN gateway (consistent with mask within the LAN 1)
4. Press [OK] to save the parameters.

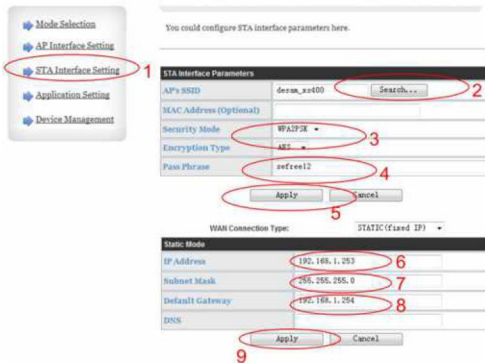

picture 1

d. A serial port and other Settings

1. Click on the left column [A serial port and other Settings]
2. Choose [server] for the network mode (the purpose is set the device as the service end)
3. Press [OK] to save the parameters.

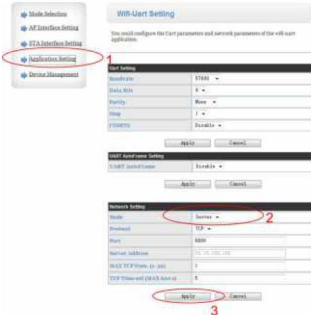

picture 1

e. Module management settings

1. Click on the left column [Module management]
2. Restart to update the setting parameters.

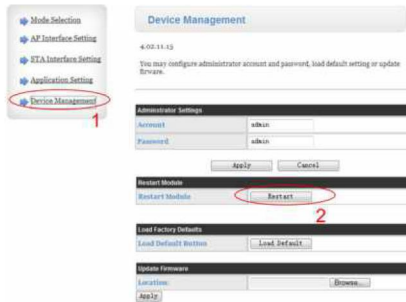

picture 1

f. Wifi module connected to the Internet Settings

Open the browser input the router gate way which connected to the internet, for example: 192.168.1.1 and enter into the router setting interface.

As the routers have a firewall, generally the computer out of the Internet can't access to the devices within LAN 1 directly, and then need to open an IP address on the router, the router DMZ host can achieve this function.

The abbreviation of the DMZ is English "demilitarized zone", Chinese name is called "isolation", also known as "demilitarized zone". It is behind a firewall in order to solve the installation of external network access user can not access the internal web server, and set up a buffer between the security system and un-security system.



picture 1

DMZ host settings:

As the picture, choose [start] for the DHZ situation.

DMZ host IP address: fill in the static IP of the outer wifi which is join the LAN Save the parameters.



picture 1

Find the IP address of the LAN to the Internet  
Click on the left column [operation state]



picture 1

As the picture, write down the IP address of the LAN to the internet  
(Notice: this IP address must be the public one, open the website www.ip138.com, in the web page, you can find that your IP address is same as the router outside IP address, your IP address is the public IP)

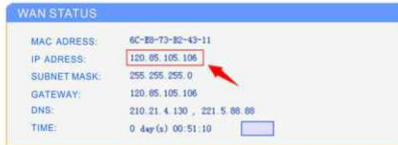

picture 1

Use the software to connect the device via internet  
Open the software and click on **[connection]** , as shown in below picture and then fill in the internet IP address

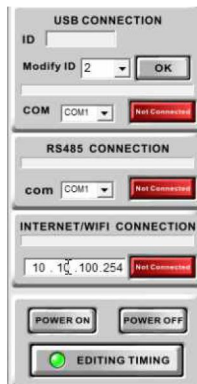

picture 1



Click on [connection], and if you see the green bar, it means connecting successfully and you can adjust the parameters for the device.



picture 1

### 1.8 The method of checking the port

#### 1.8.1 The method of checking the Window XP system port

Click the icon "my computer", Click the right mouse button, the pop-up window as follows:

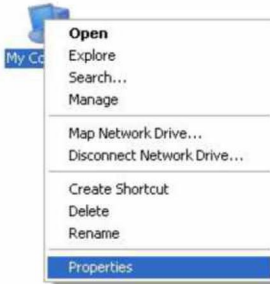

picture 1

Click the left mouse button to click [properties] and pop-up system properties window (as below)

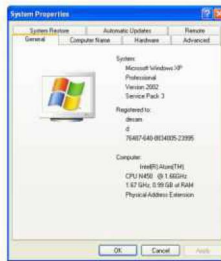

picture 1

Click on the "device manager" (as picture), then you can view the corresponding port

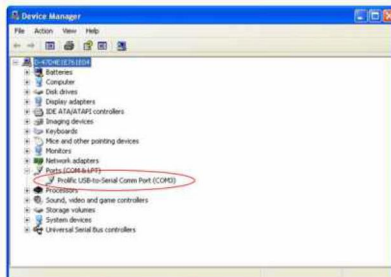

picture 1

### 1.8.2 The method of checking the Windows 7 system port

Click the icon "my computer", right click the mouse, below dialog-box will pop up.

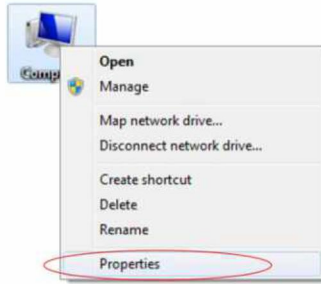

picture 1

Left click the mouse and then click [properties] and system properties window will pop-up (shown in below pic)

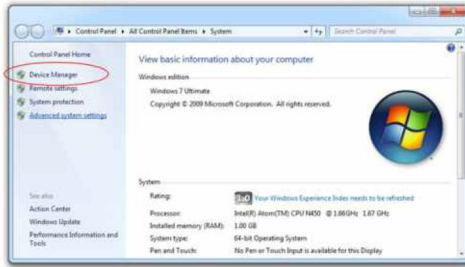

picture 1

Click on the "device manager" (shown in above as picture), then you can view the corresponding port

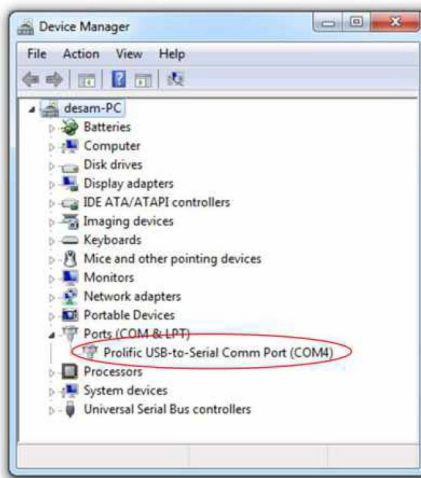

picture 1



## 1.9 The method of checking and modifying the related parameters

### 1.9.1 Check and modify the network connection parameters in the device

#### 1.9.1.1 The method of modifying the IP address under the AP mode

For example: Revise the IP address to 192.168.1.2

Step 1: Use the 1<sup>st</sup> or 2<sup>nd</sup> way to connect the device, input the device IP address on the IE browser address bar (the default device IP address is 10.10.100.254), shown as below picture:

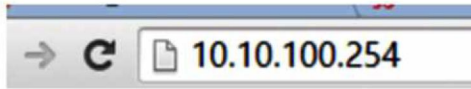

picture 1

Press the button [enter], you can see the following dialog:



picture 1

Step 2: input the user name [admin] and password [admin], press the button [enter] and enter into the configuration interface, as the picture below:

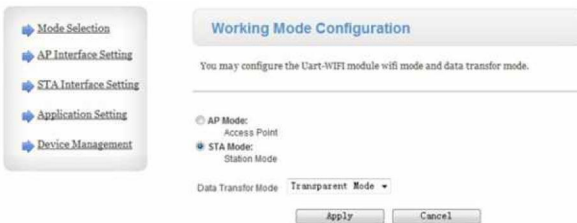

picture 1

Step 3: click on the [wireless access point settings] as shown in the below pic.





picture 1

Step 4: click on the [wireless access point settings] as shown in the pic. above and enter into the interface:

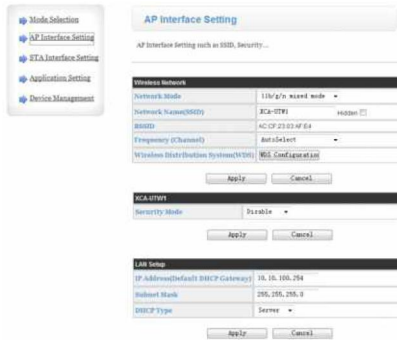

picture 1

Step 5: In the picture below, under [LAN parameters setting], modify the IP address on [IP address](The range of IP addresses is 0.0.0.0 ~ 255.255.255.255) According to network name modification steps to set IP address, press OK to save the settings.

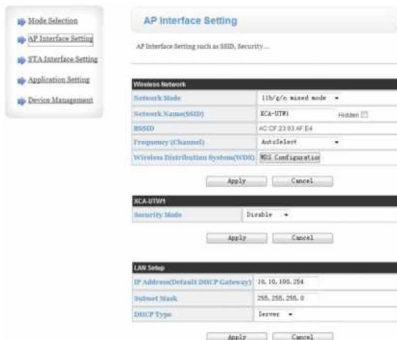

picture 1

Step 6: click on [OK] and enter into the interface as below:



picture 1

Step 7: click on the [restart module] shown in the picture below, enter into the interface below:

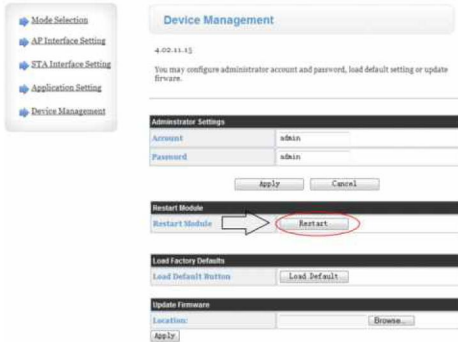

picture 1

After re-start, the IP address of the device is 192.168.1.2

1.8.1.2 The method of modifying the IP address under Station mode

For example, modifying the IP address to 192.168.1.2

Step 1: Connect the device via internet, input the device IP address on the browser address bar or "my computer" address bar (the default device IP address is 10.10.100.254). Shown in below picture.

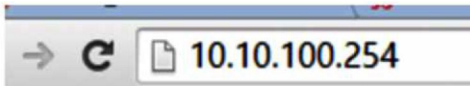

picture 1

Press the button [enter], you can see the following dialog:



picture 1

Step 2: input the user name [admin] and password [admin], press the button [enter] and enter into the configuration interface. Shown in below picture.

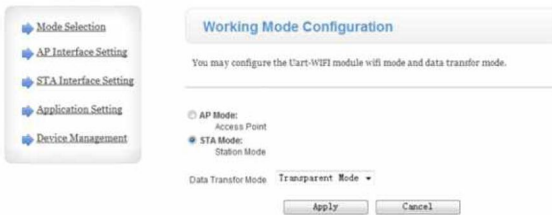

picture 1

Step 3: click on the [wireless terminal settings] shown in below picture.

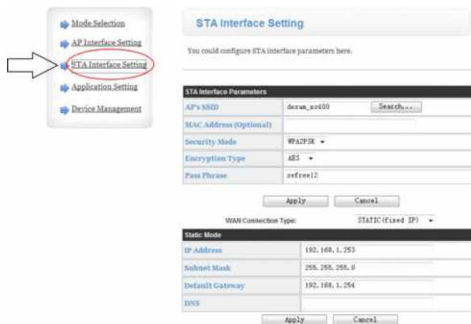

picture 1

Step 4: In the In the picture above, under [LAN parameters setting], modify the IP address on [IP address](The range of IP addresses is 0.0.0.0 ~ 255.255.255.255)



picture 1

Step 5: choose [fixed (static IP)] to enter into the following interface

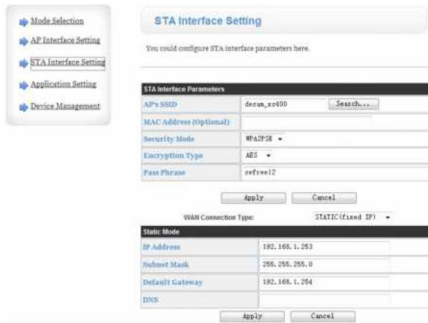

picture 1

Step 6: In the dialog below, fill in the corresponding parameters. Input the IP address which in the same network segment with router (the range of IP address is 0.0.0.0 ~ 255.255.255.255).

For example, the router IP IS 192.168.1.1 ,then the device IP could be the one from 192.168.1.0 to 192.168.1.255 ,except the router IP ,but the devices IP are different . ( For example, the device 1

IP is 192.168.1.2, and then use the IP address as the picture below). In the [subnet mask], input 255.255.255.0, in the [network segment setting], input the router IP 192.168.1.1, press [ok].

Under [LAN parameters setting], modify the IP address on [IP address](The range of IP addresses is 0.0.0.0 ~ 255.255.255.255)

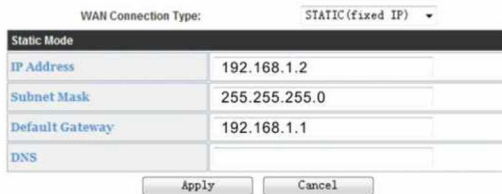

picture 1

Step 7: click on [OK] to restart wifi module to finish the modification of IP address.



1.9.1.3 The method of checking the device IP address

1.9.1.3.1 Under AP mode, the method of checking IP address

Under AP mode, the method of checking IP address for window XP system

Step 1: click on the lower right-hand corner of the screen, the icon / pop-up the following dialog:

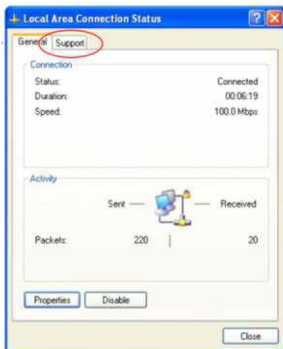

Step 2: click on "support" to enter into the following interface, the number in the red frame is the device IP address 10.10.100.254

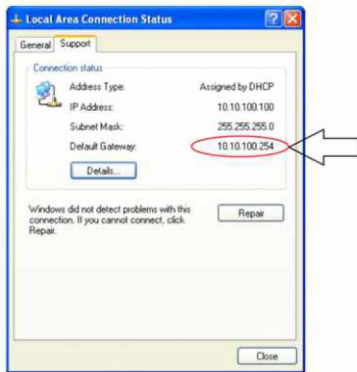

Under AP mode, the method of checking IP address for window 7 system

Step 1: click on the lower right-hand corner of the screen, the icon / pop-up the following dialog:

Step 2: click on "open internet and sharing center" (in the red frame), pop-up the following interface:

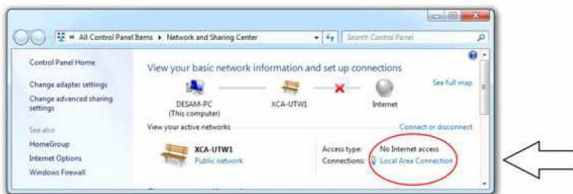

Wireless connection



Step 3: click on the red position in the picture above, and pop-up the following dialog:

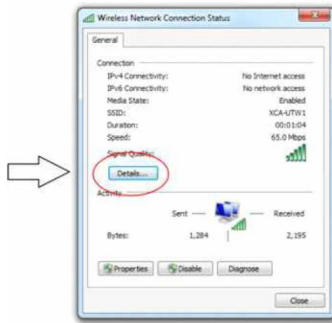

Step 4: click on the "Specific information (E)" on the picture above, pop-up the following dialog, the IP address in the red frame is the device IP 10.10.100.254

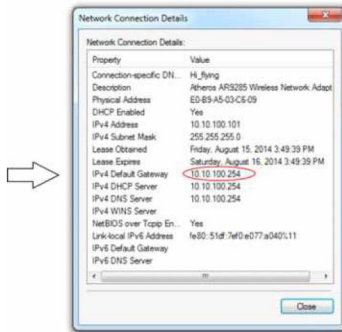

1.9.1.3.2 The method of checking the device IP address under Station mode

Under Station mode, the IP address is assigned by the router, the IP address is not the wifi module IP, and need to enter into the wifi module setting interface to view the IP, the specific methods as follows:

Take 1.6 network connection ways for reference, use the 1<sup>st</sup> way to connect the device, and try to check the IP address under AP mode via the method above, find wifi module IP is 10.10.100.254

Station mode of IP address is assigned by the router, the IP address of IP is not wifi module itself, to enter the wifi module Settings interface view, specific view as follows



Step 1: input the IP address on the address bar of IE browser or “my computer”

Notice: please be sure that the device and computer is connected before modifying the IP address.

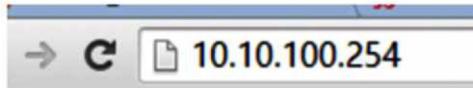

Step 2: Input the default user name [admin] and default password [admin], press the button [enter] to enter into the webpage configuration interface, find the interface as below, the IP address in the red frame is the device IP address under Station mode: 192.168.1.2

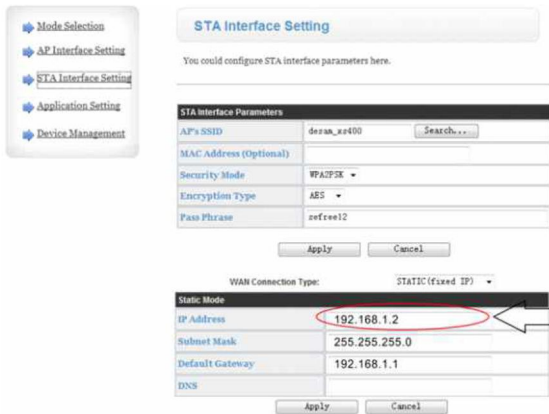

#### 1.9.1.4 The swap method of Station mode and AP mode

Using network cable to connect computer with wifi module, and open the browser after connecting, and input 10.10.100.254 on the address bar to enter into the wifi module setting interface, input the default user name [admin] and default password [admin] and log in. Find the [mode selection] to choose the mode you needed.

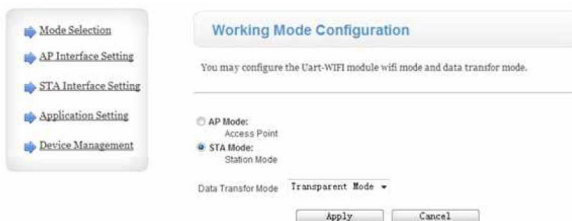

picture 1



## Part2: The method of operating the device

### 2.1 Function:

- Using ARM 32-bit processor controller, the time is more precise reliably.
- 8-channel 22KW rated power, each channel has independent high performance with CE qualification and RFI/EMI power filter to offer clean and stable power.
- LED voltage meter, real-time displays the voltage.
- LED current meter, real-time displays the current.
- LCD operating interface, displays the operating status and results.
- With an USB lamp socket and USB lamp for using the device under low-light conditions.
- Can close any output channel via device.
- Password function, the user can use or cancel the function.
- Programming function. Set up the delay time as user's requirement.
- Remote control function, the user can operate PR580 at any time.
- Can multiple cascade with the same model of the power distributor, without the requirement to purchase other control devices.
- Diverse controlling kinds: e.g. single device control, TCP IP/WIFI/485/323 cascade control plus outer(remote) to control complicate power system.
- Diverse controlling ways: USB, RS485, WIFI(optional), remote internet control.
- Timer switch function for up to 1 year.
- Using the socket of Chinese standard, American standard and European standard to meet different plugs.

### 2.2 Introduction of front panel

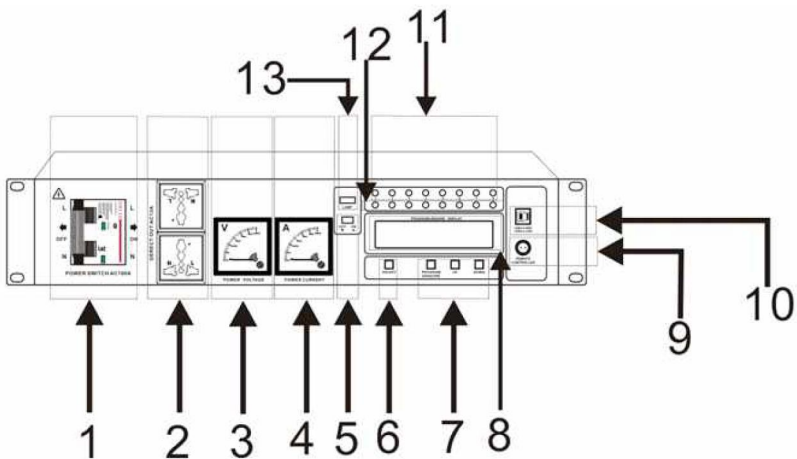





1. Power Switch: power switch with earth leakage protection.
2. Power socket: Each output current maximum 13A
3. Voltage indicate: input and output voltage indicator
4. Current indicate: input and output current indicator
5. DJ lamp button  
Press button ON, the lamp lights and press button OFF, the lamp not lights.
6. Sequencer ON/OFF button  
Press this button for 2 seconds and indicators (1-8) in the emergency channel will twinkle in sequence.
7. Program setting button  
Long press the button "PROGRAM&INQUIRE" 1 time, LCD screen will display the device ID.  
Long press the button "PROGRAM&INQUIRE" 2-time, LCD screen will display the "year,month,day and specific time".  
Long press the button "PROGRAM&INQUIRE" 3-time, LCD screen will display IP address.  
Press button "UP" and "DOWN" to change the parameters.
8. LCD screen  
Displaying the ID, year , month , day, time and IP address.
9. Remote control aviation socket.
10. USB/WIFI connection socket.
11. Emergency channel indicator
12. Emergency button  
Press the button and the matched indicator will light.
13. DJ lamp connection socket

### 2.3 Introduction of back panel

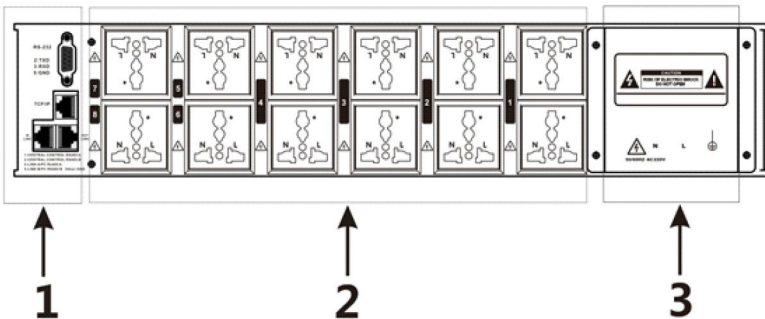

1. Central control 232/TCP IP/ cascade / central control 485 connection port.
2. 8 output power socket.
3. Power input connection



## 2.4 SPECIFICATION

Model	<b>PR580</b>
Voltage	Single-phase: 220V
Power frequency	50Hz or 60Hz ( $\pm 5\%$ )
Power input	Single-phase, 3-pin socket 100A cable input
Power control	Single-phase 2-pin air socket, with current limiting protection and short circuit protection
Display	LCD display
Sequencing channel	16 sequence channels with independent control
Power output	The total overload current is 100A a. Under audio load, each channel is 40A, the 3 <sup>rd</sup> and 4 <sup>th</sup> channel are 26A b. Under pure resistance load, each channel is 20A, the 3 <sup>rd</sup> and 4 <sup>th</sup> channel are 13A
Time sequence	Programable
Switch	PC software locking , can close it
Voltage error	None
Grounding resistance	R=100 $\Omega$
Unit mass	2U
Product dimension ( W x D x H)	482x400x88mm
Net weight	10.25kg
Product dimension ( W x D x H)	1PC: 607x183x524mm/0.0582m <sup>3</sup> 3PCS:622x599x539mm/0.2008m <sup>3</sup>
Gross weight	11kg



## 2.5 Menu setting method

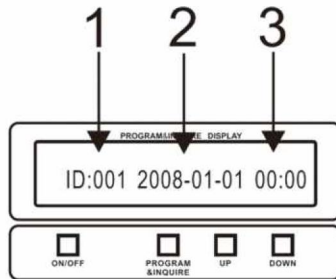

### 1.ID Setting

Step1: Power on the device

Step2: Long press button “PROGRAM&INQUIRE” one time, twinkle LCD and setting ID(ID SET)

Step3: Press“UP”to add the ID value, press “DOWN” to reduce the ID value.The updated value can be saved under twinkling status.

### 2&3. Year.Month.Day and time setting

Step1: Power on the device.

Step2: Long press button “PROGRAM&INQUIRE” two times ( long press “PROGRAM&INQUIRE”one time, twinkle LCD enter into ID setting interface. And then long press“PROGRAM&INQUIRE”again), twinkle LCD enter into “year/month/day”setting interface(TIME SET)

Step 3: Twinkling “year”,press “up” to add value or press“DOWN”to reduce value.

Step 4: Short press“PROGRAM&INQUIRE”, twinkling “ year” to “month”, press “up” to add value or press“DOWN”to reduce value.

Step 5: Short press“PROGRAM&INQUIRE”, twinkling “ month ” to “day”, press “up” to add value or press“DOWN”to reduce value.

Step 6: Short press“PROGRAM&INQUIRE”, twinkling LCD to setting time.

Step 7: Twinkling “hour”, press “up” to add value or press“DOWN”to reduce value.

Step8: Short press“PROGRAM&INQUIRE”, twinkling “ hour” to “minute”, press “up” to add value or press“DOWN”to reduce value.

Step9: Short press“PROGRAM&INQUIRE”, twinkling “ minute” to “second”, press “up” to add value or press“DOWN”to reduce value.

### IP setting

Step1: Power on the device.

Step2: Long press button “PROGRAM&INQUIRE” three times ( long press “PROGRAM&INQUIRE”one time, twinkle LCD enter into ID setting interface. And then long press“PROGRAM&INQUIRE”one time, twinkle LCD enter into time setting interface, long press“PROGRAM&INQUIRE”again), twinkle LCD enter into IP setting interface(IP SET).

Step3: Short press “PROGRAM&INQUIRE”,twinkle LCD to other IP values, press “up” to add IP value or press“DOWN”to reduce IP value.

Step4: After changing the IP, long press “PROGRAM&INQUIRE” to save setting, back to menu.



## 2.6 The method of connecting remote control

The port of remote controller can switch the device

The method of connecting as picture 1 :

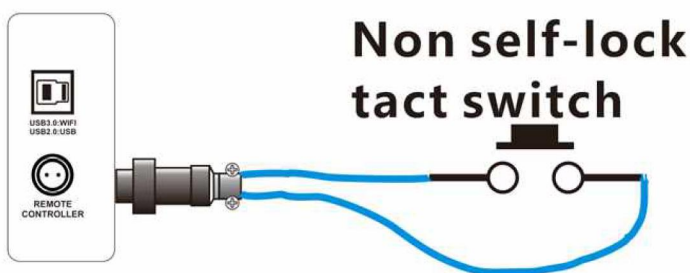

picture 1



### Part3. The installation and use of PC software

The first time we use the device, we have to install below:

1. USB driver;
2. PC control software.

#### 3.1 The USB driver installation

Find the included CD and insert into PC CD ROM.  
Open the folder "Application" and copy in computer.



picture 1

Open it and double click "USB\_Driver" to install the program. As following picture:

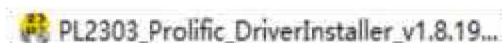

picture 1

(Attention: Install the USB Driver without need of setting, just click on "Next" until the installation finishes.)

#### 3.2 The installation of software

Find the included CD and insert into PC CD ROM.  
Open the folder "Application"  
Copy the document "X-SV1.00" ( Version number: 1.00) in the computer.



picture 1

Open the folder "X-SV1.00", double click "PR580" to operate the software.  
As following picture:



picture 1



### 3.3 Connecting the software

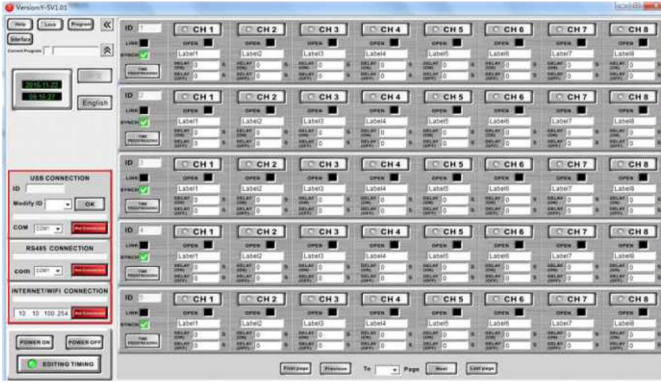

picture 1

1. The method of connecting PC and the device, please read “Part1: The method of connecting device” for reference.

### 3.4 The solutions of disconnection problem

- (1) If the computer or USB cable or device has problem, the single device cannot be connected.
- (2) If several devices can not be connected, the 485 converter may have problem.
- (3) Possible problem with computer:
  - a. USB port is damaged, please change another USB port then connect again.
  - b. The COM port can not be detected, showing the installation of USB driver is incorrect, please re-install USB driver program then connect again.
  - c. The computer software is starts abnormally, please close the software and re-open the software then connect again.
- (4) Possible problem with USB cable:
  - a. USB plug is damaged, please change another USB cable then connect again.
  - b. The USB port can not be detected, please re-insert the USB cable then connect again.
- (5) Possible problem with device:
  - a. The device is not open, please open the device then connect again.
  - b. The device is still starting, please wait until the device is under working status then connect again.
  - c. The USB port is damaged, please repair it.
- (6) Possible problem with 485 converter:
  - a. The cable connection of 485 converter and device has problem, please change another network cable then connect again.
  - b. The 485 converter is damaged, please change another 485 converter then connect again.
- (7) The problem which can not search WIFI module signal  
Please check if the wireless mode is AP mode.  
The method of modifying the mode, please take <1.8.1.4 Method of exchanging Station mode and AP mode > for reference.



### 3.5 The introduction and operation of the software interface

#### 3.5.1 The connection between the software and PC & Use the software to modify the ID

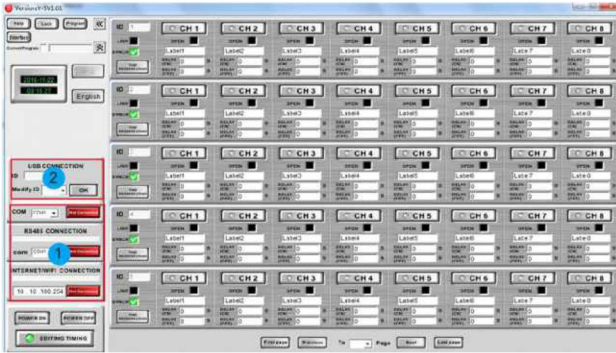

picture 1

#### 1. Connect the PC software

Please take the part 1 “device connection method ” for reference

#### 2. Use the software to modify the device ID

Step 1: Connect the device and PC via USB

Step 2: Modify the ID to the number you needed, click on button [ok],as the picture below:

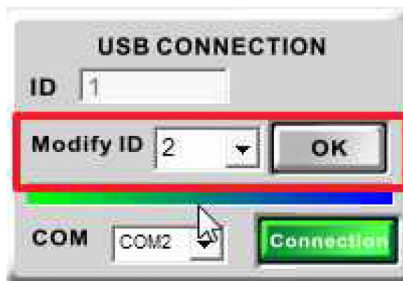

picture 1

### 3.5.2 The introduction of the software function

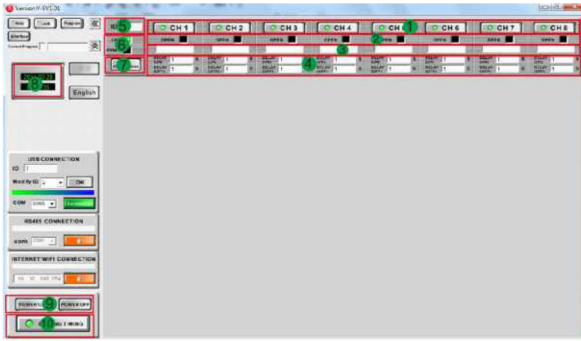

picture 1

#### 1. The channel state settings

Click on the button to switch the corresponding channel state. When the light is green, it means the corresponding channel indicator lighting. As the picture below:



picture 1

#### 2. Channel normally opens options

Click on the option frame to change the channel normally open state. When choose this option, the channel is in the normally open state, the channel will remain in the condition of the output voltage (supply power for some special



picture 1

#### 3. Channel label.

Mark the channel label.

#### 4. Open and close the channel delay

When the sequential open or close, the delay parameters between the channels, the range is 0-999 seconds.

#### 5. Showing the current device ID number.

#### 6. The working state of the sequencer

The device has two kinds of working state, link state and synch state, click on to change the working state

The difference between device state and synch state:

1. Under the working conditions, all the state of the single device is identical.

The difference between power-on and power-off under the cascade condition:

1. All the cascade devices are under linking state

When the device is cascaded, click the button "power on", from ID 1 beginning, the device is opened in turn by the "Delay on" parameters. When click the button "power off", from the biggest ID beginning, the device is closed in turn by the "Delay off" parameters. (The channels which be set "normally open" is opening)





2. All the cascade devices are under sync state  
When the device is cascaded, click the button “power on”, the device is opened in turn by the “Delay on” parameters. When click the button “power off”, the device is closed in turn by the “Delay off” parameters.
3. In the cascade devices, with link state and synch state.  
When the device is cascade, click the button “power on”, all the devices which under the synch state will open in turn by the “Delay on” parameters. The devices which under the link state will open in turn from ID 1 by the “Delay on” parameters. When click the button “power off”, all the devices which under the synch state will open in turn by the “Delay on” parameters. The devices which under the link state will open in turn from the biggest ID by the “Delay off” parameters. (The channels which be set “normally open” is opening)
7. The time proofreading and time display  
Click on the button enter into the timing setting menu. As the picture below:



picture 1

8. Power on and power off  
Click on the button “power on” and “power off” to operate. When the device under linking state, please take the 6<sup>th</sup> point “device working state” for reference to power on or power off.
9. Editing timing  
Click on the button “editing timing”; enter into the interface to set the parameters of power on or power off. As the picture1 below, the specific method please Read “3.5.3 Introduction of editing timing function” .



picture 1



### 3.5.3 The introduction of “Editing timing” function



picture 1

Notice: 1. When use the function of timing power on/power off, the device ID must be 1. If the ID is not 1, the function is invalid.  
 2. When change beginning date, the parameters set before is invalid, please be noted.

1. Setting the beginning time.  
 Setting the beginning date, this device can set timing parameters for 12 months. When we change the beginning date, the parameters set before is invalid, please be noted.
2. Timing switch  
 When choose this option, the function of timing switch will work.
3. Month timing parameters settings  
 Edit the parameter to change the month timing data.
4. Save the timing power on/off data
5. Weekly repeat and monthly repeat  
 This device with 2 kinds of timing mode, when choose “weekly repeat” use the weekly repeat data for timing parameters, or will use the monthly repeat data for timing parameters.

For example 1, Use the month timing mode, the current time is March 12,2015, set the timer start from March 15,2015 8:00am and close at 12:00am;  
 Start from 2:00pm and close at 10:00pm.

Step 1: Choose the timing start date – Jan, 2015 (the date should be within the time from “timer start date” to “timer deadline date”,  
 As the red frame shown in picture below:



picture 1



Step 2: Click on the button “last month” and “next month” to make the timing editing interface switch to March, 2015. As the red frame below:



picture 1

Step 3: Click on the No.15 (as the red frame), switch the rest day to be working day (as picture 2), and click on the button [EDIT] (as picture 2), on the pop-up window. Edit the device power on 8:00 and power off at 12:00, power on 14:00 and power off 22:00; press the button [OK] to return the editing interface of timing function.



picture 1



picture 3



picture 2

Step 4: Click on the button [OK] to save the data to the device. After the 4 steps settings, the device will automatically power on at 8:00 March 15<sup>th</sup>, 2015 and power off at 12:00. Power on at 14:00 and power off at 22:00. The editing interface as below:



picture 1

“Weekly repeat” timer mode

When choose “weekly repeat”, the timer data is the “weekly repeat” data. As the picture1 below:

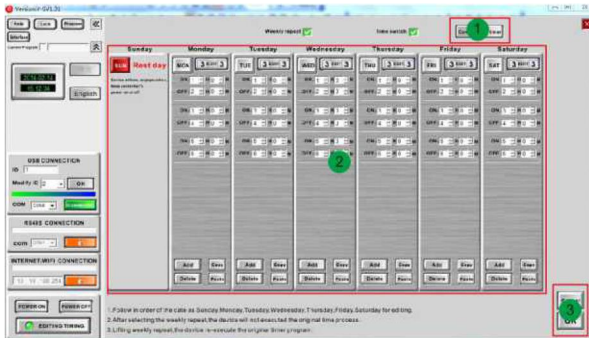

picture 1

1. Cover month timer
- Click this button, the week timer data will cover to the month timer parameters.
2. The editing area for week timer data
3. Send the week timer data to the device

For example 1 : Use the “timer weekly repeat” function to set the device power on at 8:00 from Monday to Friday , and power off at 12:00, power on at 14:00 and power off at 22:00. And set Saturday and Sunday to be rest day.

Step 1: Click on the button [timer switch], choose “weekly repeat” to make the function works, as the red frame in the picture below:



picture 1



Step 2: Set the Saturday and Sunday to be the rest day.  
Click on the button to switch to rest day (as the red frame in picture 1 below)

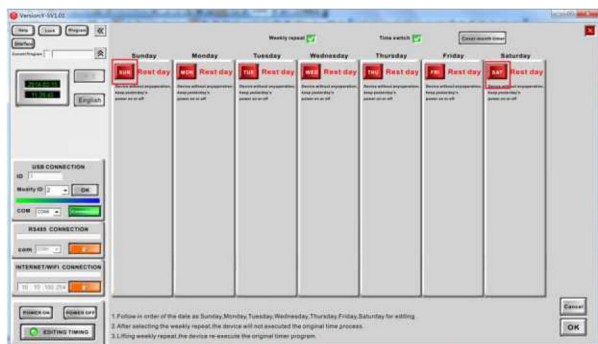

picture 1

Step 3: Set the device power on at 8:00 from Monday to Friday, and power off at 12:00, power on at 14:00 and power off at 22:00.  
Click on the button to switch to working day, and edit the timing parameters as picture 1 below, use the same steps to edit Tuesday to Friday, as the picture 2. Click on the button [OK] to save the parameters.

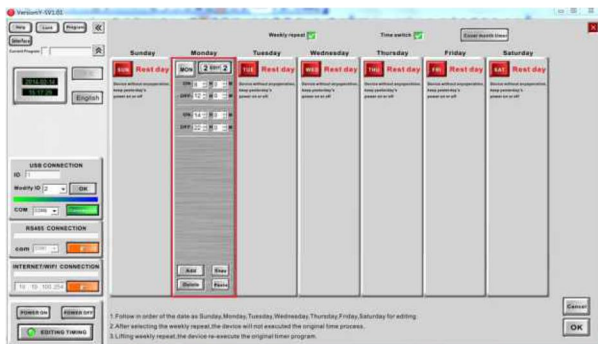

picture 1

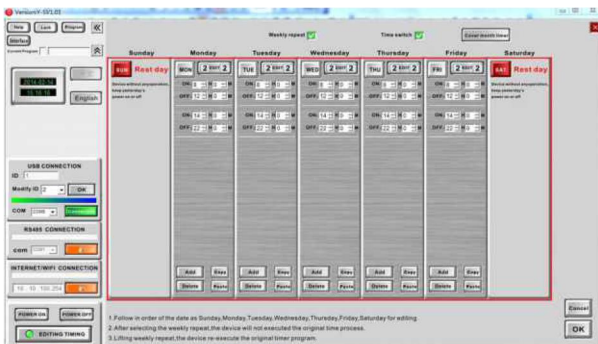

picture 1



For example 2: Use the “cover month timer” function the edit the timer parameters from January to December. Set the current time is Jan.2015, it needs to set the national legal holiday, Saturday and Sunday to be the rest day, about the other days, timing start at 7:00 and close at 12:00, start 13:00 and close at 22:00.

Step 1: Connect the PC software and device. Set the start date is Jan.2015. Click on the button “timer switch”. Click on [Editing weekly repeat] (as the picture below) and edit all the data as picture 2:



picture 1

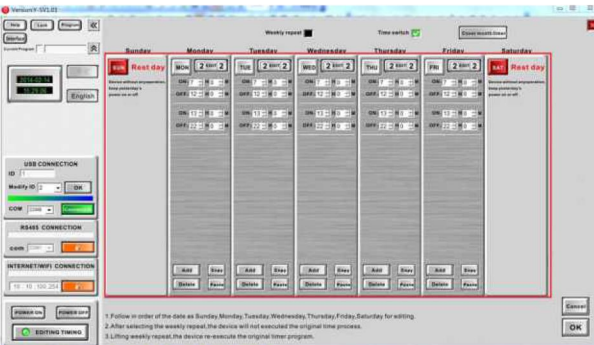

picture 2

Step 2: Click on the button [Cover month timer] (as pic.1), cover the data to monthly timer. As the pic.2

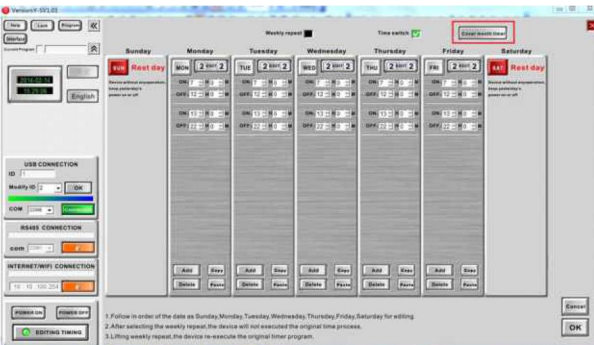

picture 2

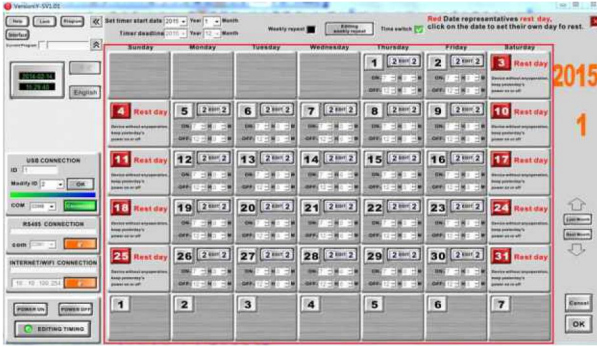

picture 2

Step 3: Change the national legal holiday to be the rest day. Including the New Year's Day, Spring Festival, tomb-sweeping day, Labor Day, Dragon Boat Festival, Mid-Autumn festival and National Day. As the picture below, according the National Day holiday, make Oct. 1st -7th to be the rest day, and Oct. 10th is working day. Press the button [OK] to save the data.

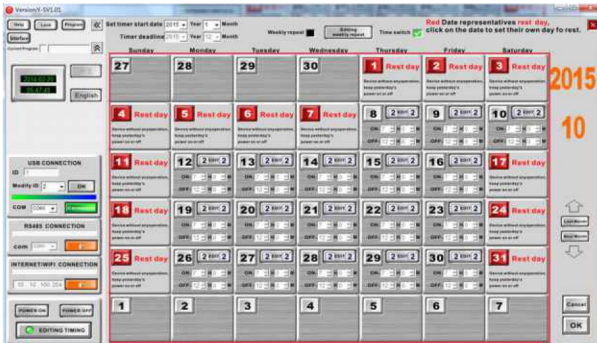

picture 1

### 3.5.4 The lock function for PC software and device

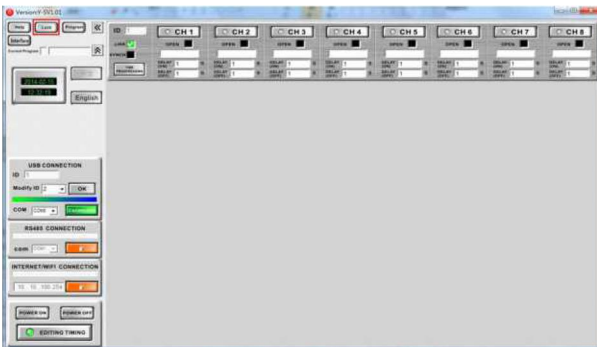

picture 1



Click on the button [Lock], pop-up the function menu as the picture 1.



picture 1

Choose any way to enter into the lock option interface. As the picture below:

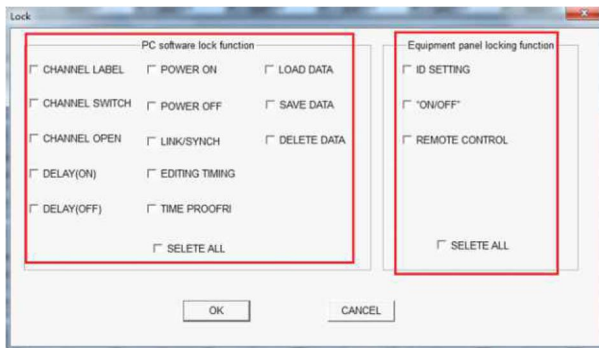

picture 1

1. PC software locks function

- Channel label
- Channel switch
- Channel open
- Delay on
- Delay off
- Power on
- Power off
- Link/synch
- Editing timing
- Time proofri
- Load data
- Save data
- Delete data

2. Device panel lock function

- ID setting
- Button "ON/OFF"
- Remote control switch





### 3.5.5 Load and save the data

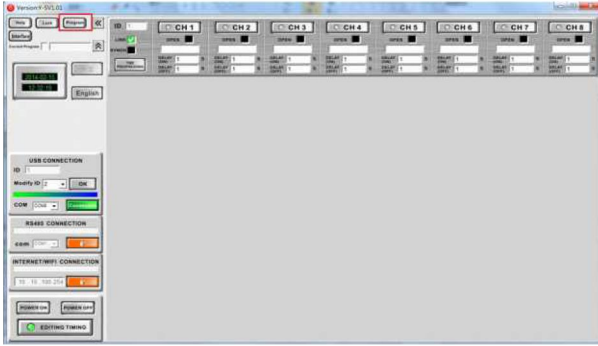

Click on the red frame ---"program" of the picture above, and pop-up the window below:

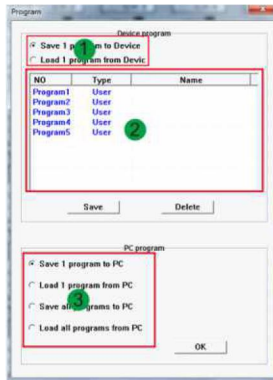

picture 1

- ① Device Program: Save the data in the device for calling and saving.
- ② List the saved data of the device, it can save the data via item number and name
- ③ Computer program: Save the data in the computer for calling and saving

**DISTRIBUTED BY**