



Contents

Contents.	1
Important note.	2
Control elements.	3
Rear panel features introduction.	4
Audio input connections.	5
Audio output connections.	6
Audio output connections.	7
Professional Power Amplifier Specifications.	8

Important Note

WARNING NOTICES

SAFEGUARDS

Electrical energy can perform many useful functions, This unit has been engineered and manufactured to assure your personal safety. Improper use can result in potential electrical shock or fire hazards. In order not to defeat the safeguards, observe the following precautions for its installation, use and servicing.

Explanation of Graphical Symbols



**CAUTION
RISK OF ELECTRIC SHOCK
DO NOT OPEN**



**CAUTION
RISK OF ELECTRIC SHOCK:
OPEN ONLY IF QUALIFIED
AS SERVICE PERSONNEL**

**WARNING: TO PREVENT FIRE OR ELECTRIC SHOCK, DO NOT EXPOSE
THIS EQUIPMENT TO RAIN OR MOISTURE**

IMPORTANT NOTE

ATTENTION: This unit must be protected from damp because of the risk of fire and the possibility of electric shocks.

1. Make sure that you have the correct mains voltage. Only operate the unit at the mains voltage marked on the rear panel.
2. Make sure that nothing especially no metal objects are inserted into the device. This could result in electric shock or malfunction.
3. If the unit is subjected to extreme fluctuations of temperature e.g. On being transported from outside into a heated room, condensation can form. This unit should not be used until it has reached room temperature.
4. In the event of water or any other fluid being accidentally spilt on the unit switch the unit off immediately and send it to a qualified service workshop for inspection.
5. Make sure that the unit is always well ventilated and never exposed to direct sunlight
6. Do not use sprays to clean the unit as they have a detrimental effect on the unit and could ignite suddenly.
7. The machine use single power switch, please cut off the power before fix.
8. Please do not put the cup, vessel of flower or container above the machine, in case the leak out water then cause the leakage current off the machine.

Control elements

Front Panel

The front panel LED area includes the following indicators per channel:

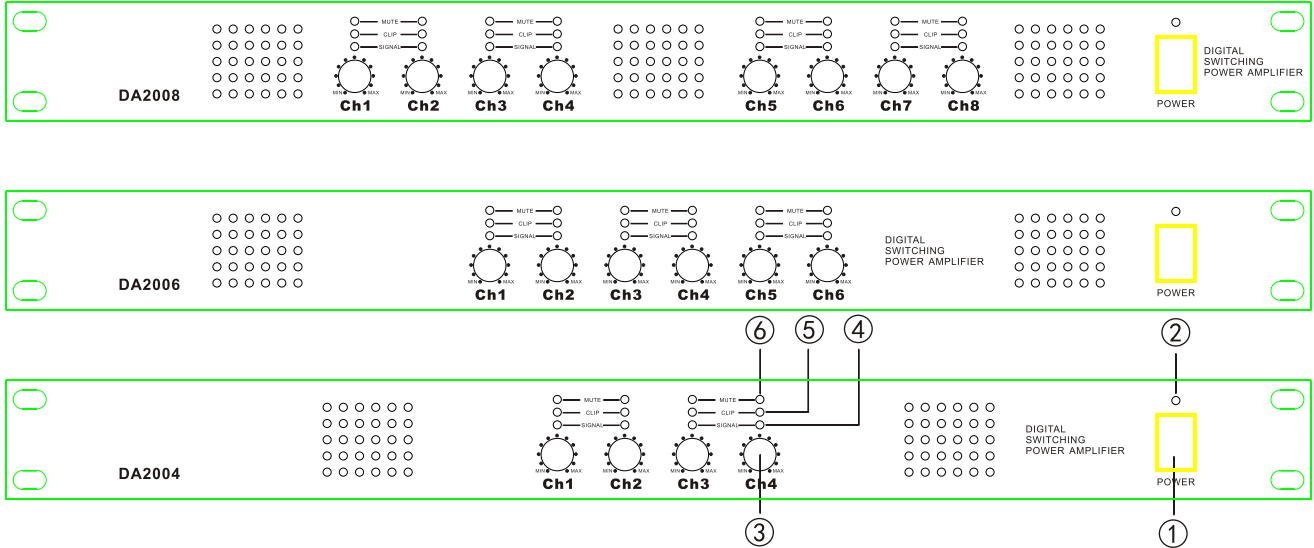

1. POWER SWITCH

Turn the unit power on or off

2. POWER LED

Indicate power on or off

3. LEVEL CONTROL

Calibrated detente potentiometers to alter the total gain of the power amplifier. In order to avoid distortions in mixing consoles upstream, The calibrated markings show the additional attenuation directly.

4. SIGNAL LED

Green SIG Indicates output signal levels in normal operating range

5. CLIP/LIMIT INDICATOR

This indicator signals if the amplifier output is clipping or limiting. When the LED lights up, the limit power function is working. If the LED flashes briefly, this is not a cause for concern. If this LED is lit permanently, the volume should be reduced to avoid overload damages to the connected loudspeaker systems.

6. MUTE LED

MUTE-Audio protection under mute position.

Rear panel features introduction

DA2004

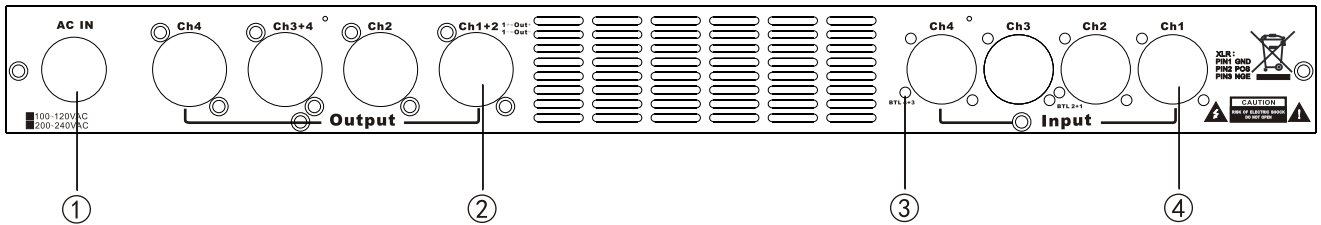

DA2006

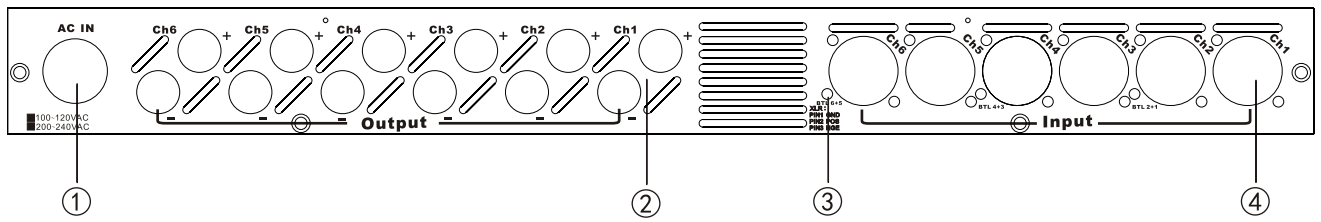

DA2008

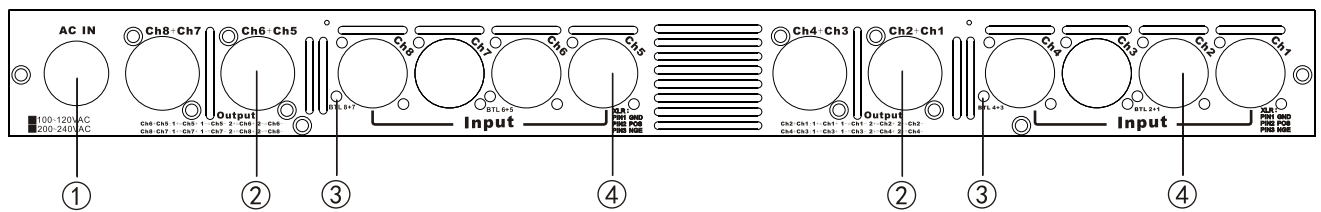

1. POWER SUPPLY INPUT
2. AMPLIFIER OUTPUT
3. BTL MODE
4. AUDIO INPUT

Audio input connections

BALANCED INPUT CONNECTIONS

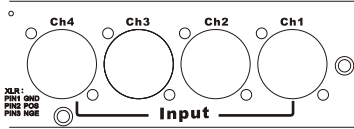

The XLR input connectors are electronically balanced, and wired according to the IEC 268 standard (pin 2= hot). XLR input connectors should be wired as follows:

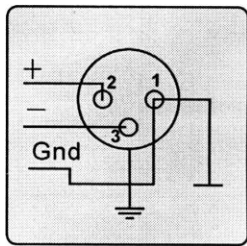

- Pin 1 Ground/Shield
- Pin 2 Hot (+)
- Pin 3 Cold (-)



When linking the same source signal to several input channels, be aware that there is a limit to the number of channels an output source can "drive". A typical output source (e.g. a DSP crossover unit) can drive up to two amplifier channels before external line-drivers might be required to buffer the signal.

Unbalanced Input connections

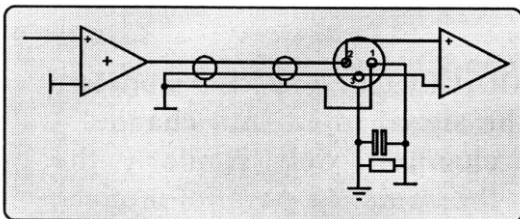

To connect an input to an unbalanced source, it is possible to connect pins 1 and 3 in the XLR plug at the amplifier end of the cable. However, a better method is to connect pin 3 to the shield at the source end of the cable, as this usually results in better hum and noise rejection. Balanced input connections are recommended whenever possible.



Audio output connections

Stereo Output connections

DA2004

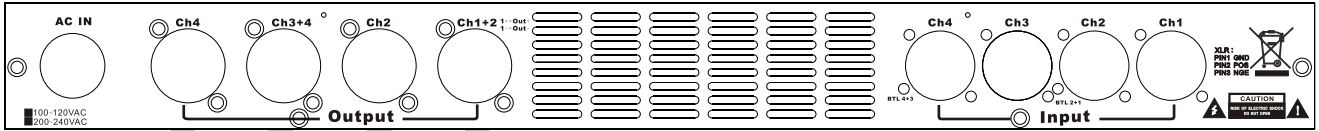

Speakon outputs-DA2004

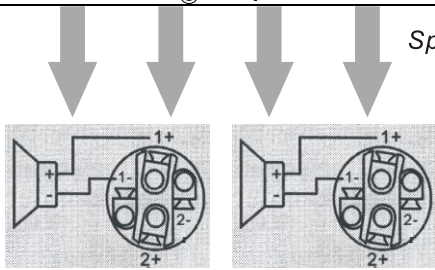

DA2008

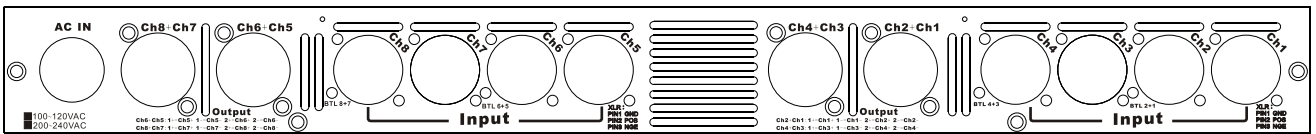

Speakon outputs-DA2008

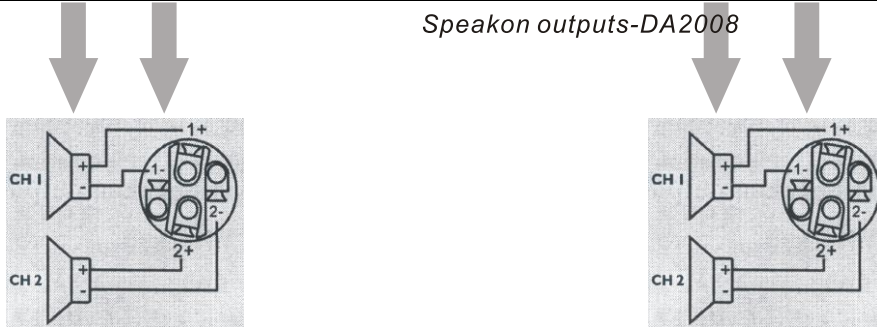

DA2006

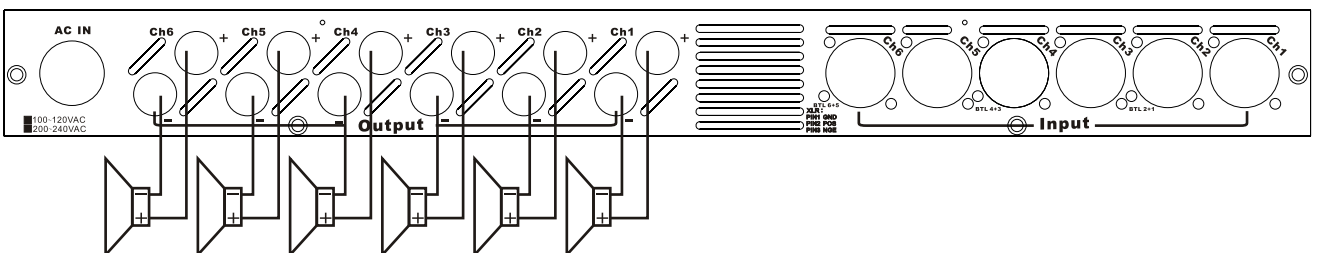



Audio output connections

Bridge Output connections

DA2004

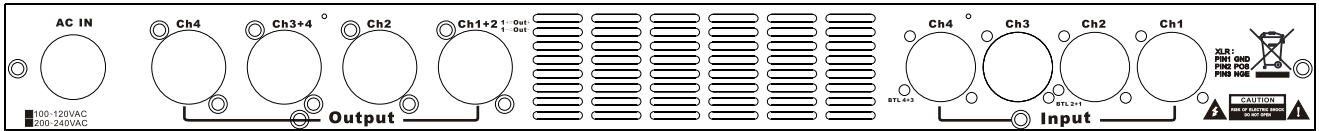

Speakon outputs-DA2004

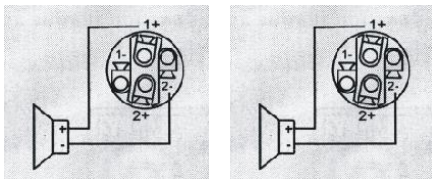

DA2008

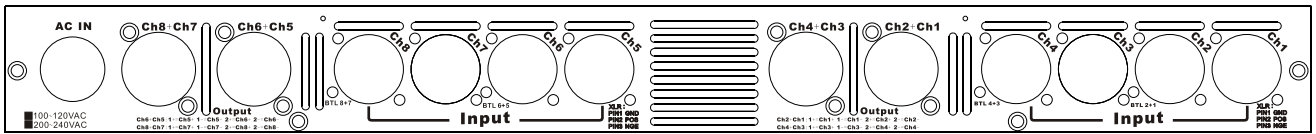

Speakon outputs-DA2008



DA2006

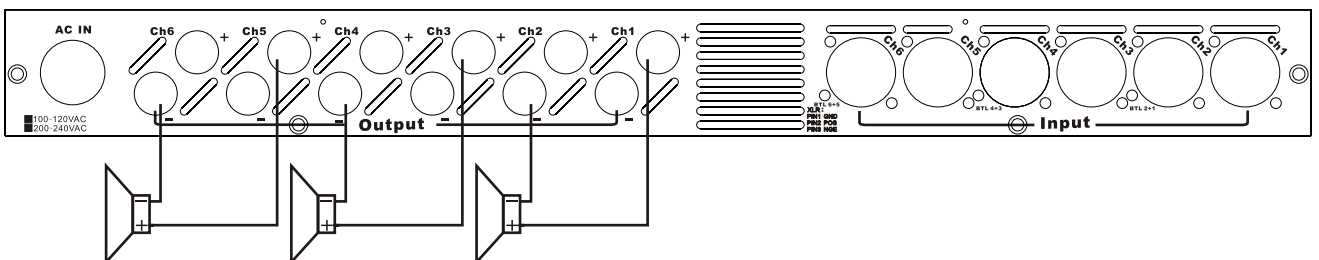



Professional Power Amplifier Specifications

SPECIFICATIONS			
ITEM	DA2004	DA2006	DA2008
Output Power			
8Ω Stereo Power	4x250W	6x250W	8x250W
4Ω Stereo Power	4x450W	6x450W	8x450W
8Ω Bridged Monon Power	4x800W	6x800W	8x800W
Frequency Response	20Hz-20KHz ±1dB		
THD+N 1KHz 1W 8Ω	<0.1%		
Signal to Noise Ratio 1KHz	>86dB		
Channel Separation 1KHz	>80dB		
Class	D		
Protection	Short, DCP, OVP, UVP, OCP, OTP		
Operating Voltage	90V-135V / 180V-265V		
Input Sensitivity	1V		
Input Impedance	20KΩ		
Dimensions(W×H×D)	483×44×325mm		
Packing Dimension	550×100×450mm		
Net Weight (kg)	4.1	4.8	5.6
Gross Weight (kg)	5.2	5.9	6.7

